

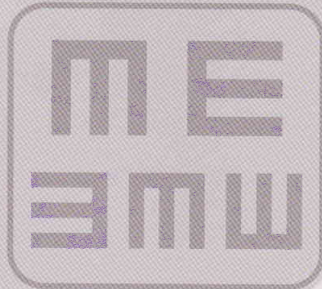

# CP-40 Chart Projector

# CP-40 Chart Projector



Aiming at new levels in quality



Offering completely new and sophisticated design features, a more cost effective model, the **CP-40** has been born.

- Now with Log MAR charts, a wider range of test charts are available.
- Two types of character layouts are available: "3 horizontal / 5 vertical lines" and "2 horizontal / 4 vertical lines".
- Vertical, horizontal, and single-character masks are available. Or, it can be fully open.



Type 7 controller panel

- Visual acuity values are displayed in the test frame.
- Charts can be changed either with the chart buttons or the arrow buttons on the controller.
- Chart units are sealed and dust-tight, and can be replaced with other units.
- With the friction method, angle of the main unit can be adjusted vertically and horizontally (tilting up and down, and swinging left and right).
- The controller offers ergonomically aligned buttons.

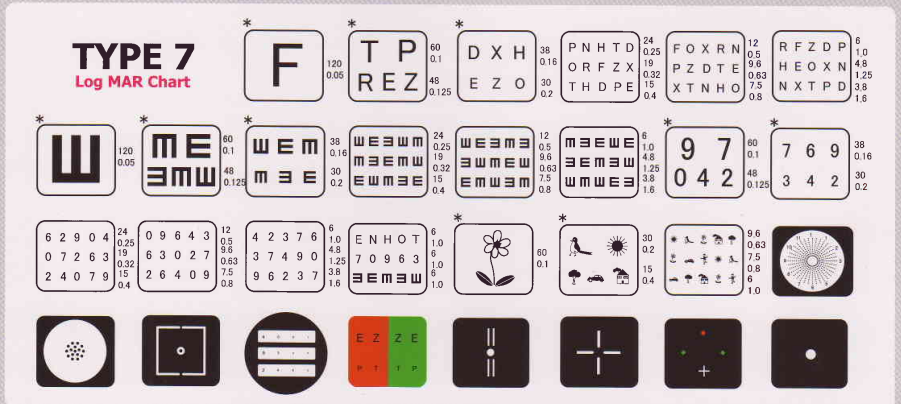

Note: the visual acuity charts with the mark "\*" are available only with the open mask.

## TYPE 2

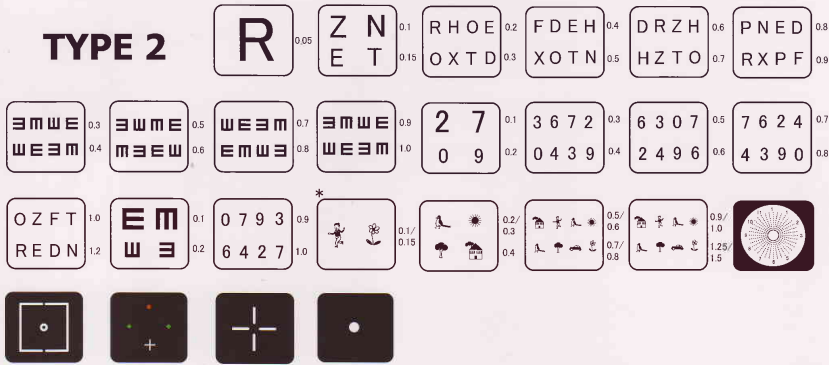

Note: the visual acuity charts with the mark "\*" are available only with the open mask.

## TYPE 9

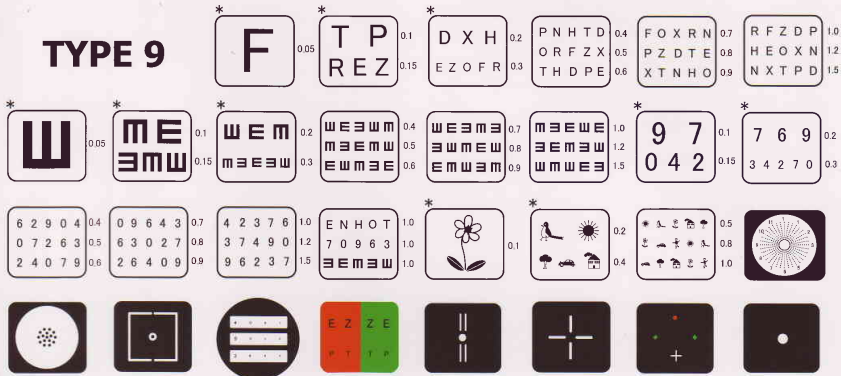

Note: the visual acuity charts with the mark "\*" are available only with the open mask.

## TYPE 8 Log MAR Chart

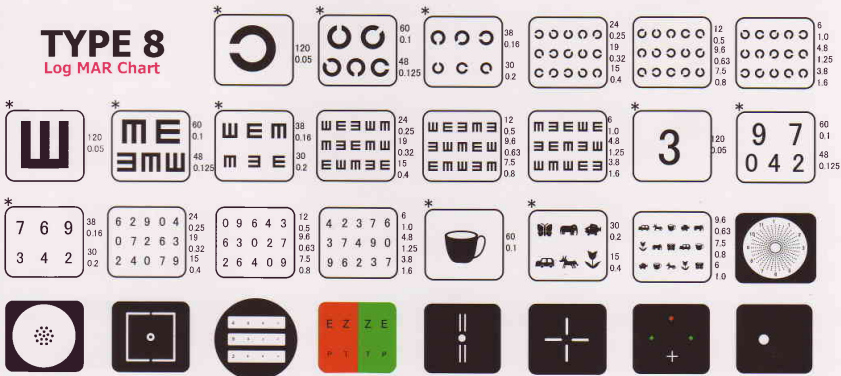

Note: the visual acuity charts with the mark "\*" are available only with the open mask.

## Dimensions

Weight: 5.5Kg

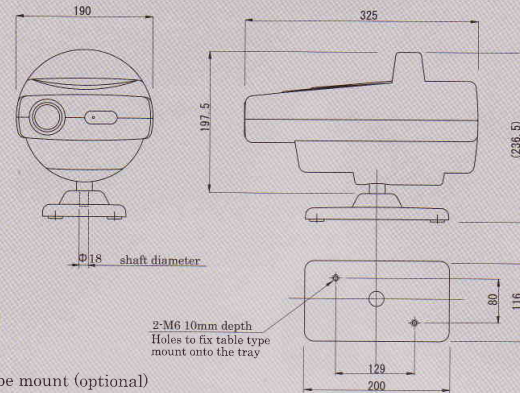

CP-40 attached to Wall type mount (optional)

## Mounts available

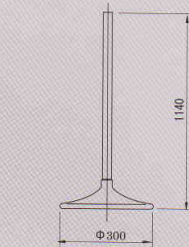

Table type mount (standard)

Wall type mount (optional)

Stand type mount (optional)

## Specifications

Projecting distance	2.9 - 6.1m
Projection size	240(W) × 216(H)mm Φ240mm (when using at a distance of 5m)
Mask	Red/Green filter ----1, Horizontal slits ----3 (4 for Type 2) Vertical slits ----5 (6 for Type 2), Spots ----15 (12 for Type 2)
Rotating speed of chart disk	0.1 sec/frame, within 0.7 sec. Maximum
Rotating speed of mask disk	0.1 sec/frame
Program provided	2 kinds with 31 steps each
Main bulb used	6V 20W halogen bulb
Power Saving	Automatically power off 10 minutes after use
Control	Infrared wireless remote control
Power source	120,230V AC, 50/60Hz
Power consumption	50VA
Mounts available	Table type, Wall type, Stand type
Tilting function	Tilts up and down / left and right



CB03002 Rev.C Printed in Japan 8,2005 KY